

SEZIONE A-A

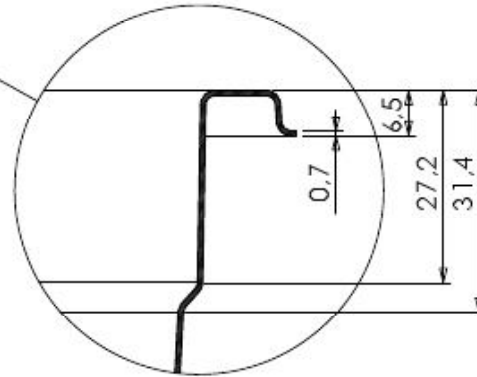

DETTAGLIO

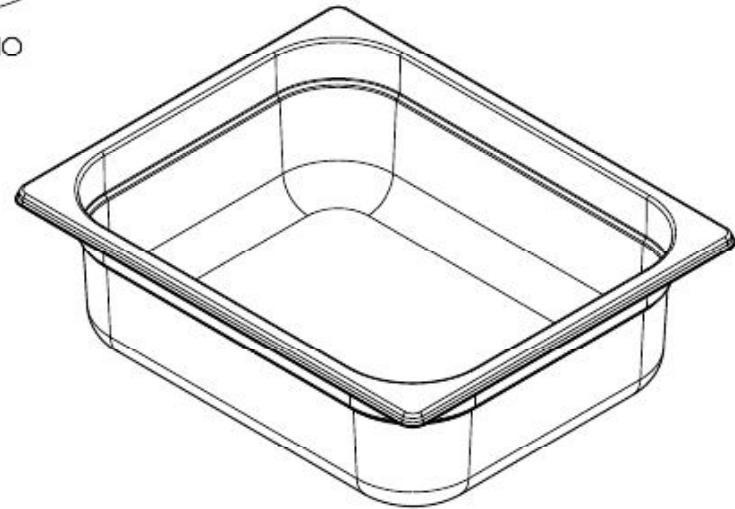
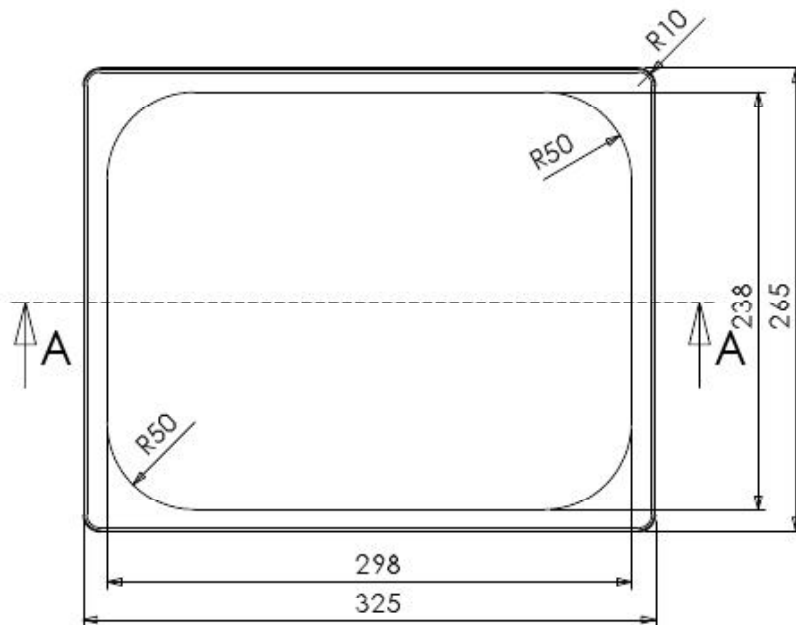
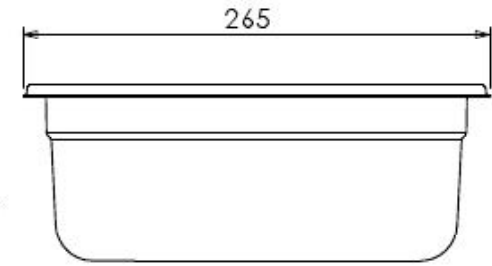

ATTENZIONE:  
SP. 0.7 mm

TOLLERANZA +/- 1 mm

**GASTRONORM 1/2x100**

NR. DISEGNO	
DATA:	08/04/2010
MATERIALE:	AISI 304
CLIENTE:	



SCALA: 1:4      FOGLIO 1 OF 1