

SEZIONE A-A

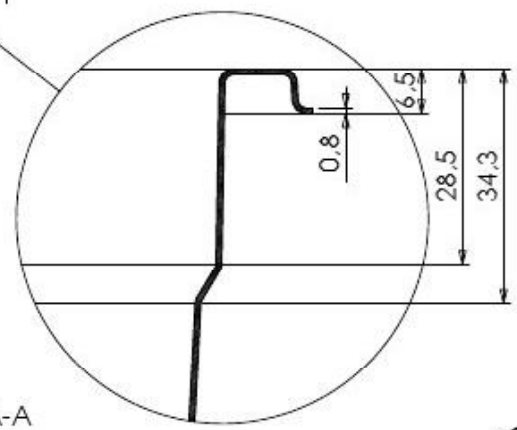

DETTAGLIO

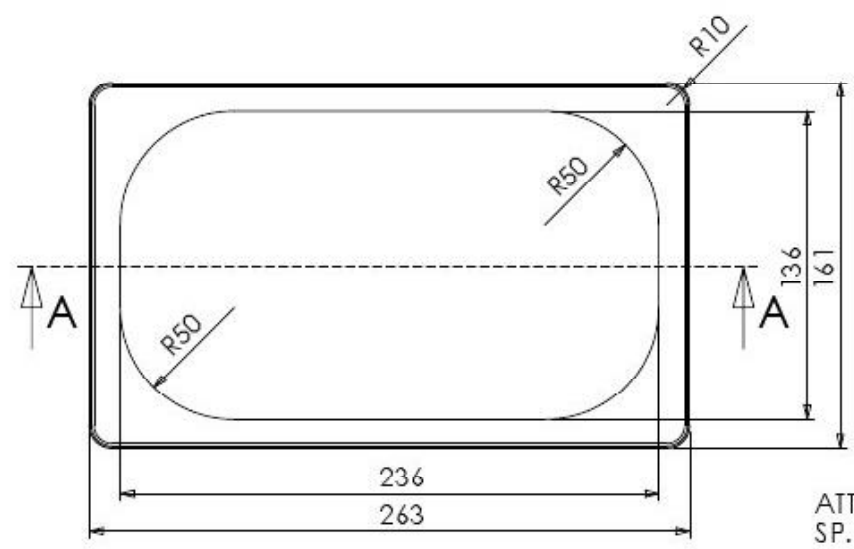
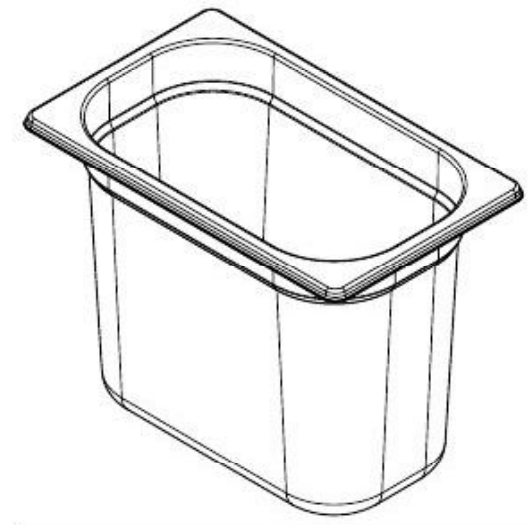
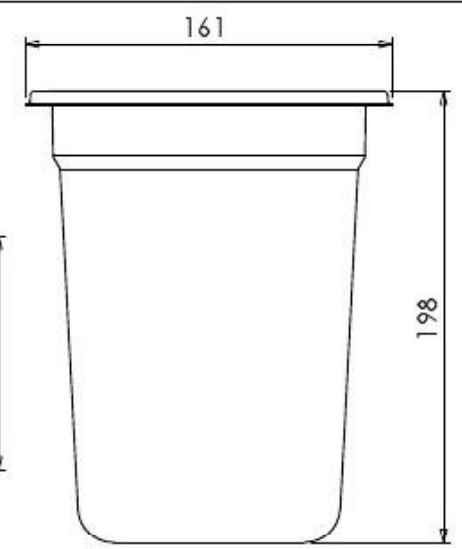

ATTENZIONE:
SP. 0.8 mm

TOLLERANZA +/- 1 mm

GASTRONORM 1/4x200

NR. DISEGNO	
DATA:	07/04/2010
MATERIALE:	AISI 304
CLIENTE:	



SCALA: 1:3 FOGLIO 1 OF 1